

(HEAD TILTS FROM 0° - 90°)

Description

The LED Slim Adjustable Wall Pack series can be widely used for indoor or outdoor lighting applications. The head tilts from 0° to 90°, allowing you to direct light in your desired angle. Durable and suitable for wet locations, it is an ideal fixture for mechanical or electronic processing workshops, storage warehouses, steel mills, gas stations, toll booth, waiting rooms, the platforms of railway station, indoor stadiums.



Applications

Wet Environments	Tunnel Roads	Wall-side Pathways
Security Lighting	Workshops	Storage Warehouses

Specs

Efficacy	130 lm/W
Input Voltage	100-277V
Finish	Black

Details

IP Rating	IP65
Materials	Aluminum
Light Angle	92°, 86°, 87°, 89°
L70 Life	75,000 Hours
Warranty	5 Years
CRI	70+
Qualification	UL, DLC 5.1, FCC, RoHS

Electrical

- Cast Aluminum Design for efficient cooling and durability
- Versatile 0° - 90° aim angle allows for optimal lighting
- Photocell controls available (optional)
- 1-10V Dimming

SPECIFICATIONS

DLC/Ordering Info	SWP02W27-50K	SWP45W27-50K	SWP07W27-50K	SWP10W27-50K
LUMENS	2720 lm	5895 lm	9170 lm	13100 lm
EFFICACY	136 lm/W	131 lm/W	131 lm/W	131 lm/W
CCT	4000K		5000K	
CRI	70			
INPUT VOLTAGE	120-277V			
POWER FACTOR	0.98			
DRIVER EFFICACY	90%			
DIMMING	1-10V Dimming			
LIGHT ANGLE	92°	86°	87°	89°
LIFESPAN	75,000 Hours			
WORKING TEMPERATURE	-22° F to 113° F			
STORAGE TEMPERATURE	-40° F to 176° C			
OUTDOOR RATING	IP65			
CABLE	Input Connect, No Cable			
WARRANTY	5 Year Limited Warranty			

LED Adjustable Wall Pack

Dimensions

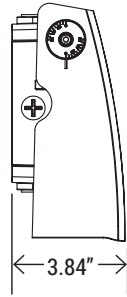
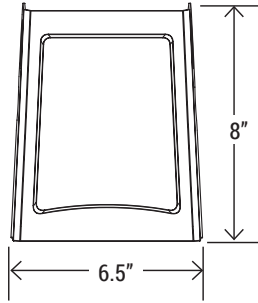

WATTAGE	U-AWP-20 U-AWP-45
NT. WEIGHT	2.9 lbs / 3.4 lbs
BOX DIM.	10" x 7.87" x 5.7"

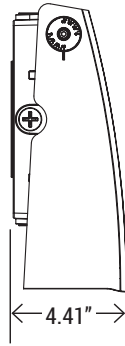
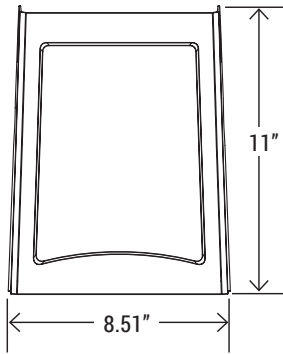

WATTAGE	U-AWP-70
NT. WEIGHT	5 lbs
BOX DIM.	12.9" x 10.23" x 5.9"

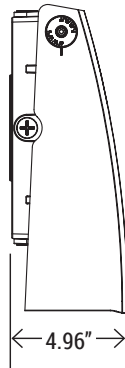
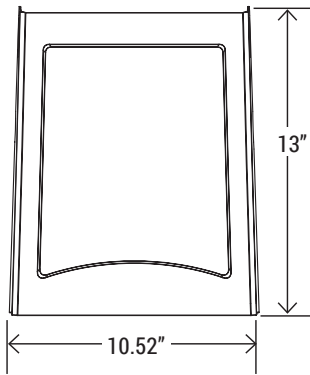

WATTAGE	U-AWP-100
NT. WEIGHT	7.3 lbs
BOX DIM.	14.9" x 11.8" x 7"

LED Adjustable Wall Pack

PHOTOMETRICS

U-AWP-20W-50

LUMINOUS INTENSITY DISTRIBUTION DIAGRAM

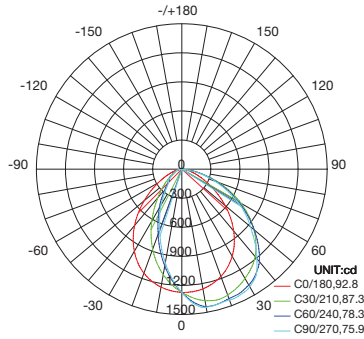

AVERAGE BEAM ANGLE(50%):83.6 DEG

C0 PLANE ISOLUX DIAGRAM (UNIT:lx)

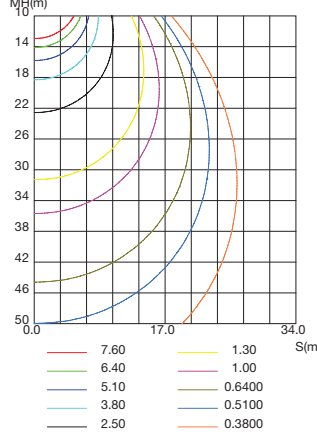

ISOLUX DIAGRAM

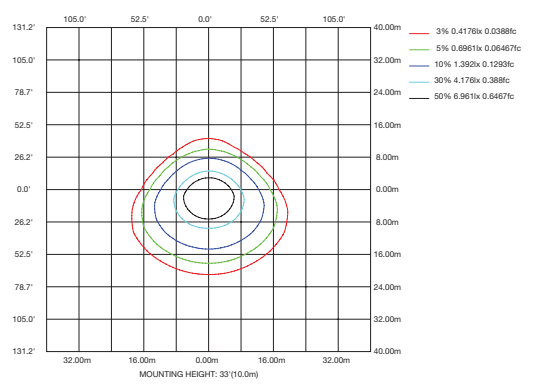

U-AWP-45W-50

LUMINOUS INTENSITY DISTRIBUTION DIAGRAM

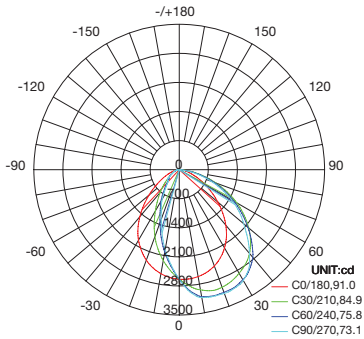

AVERAGE BEAM ANGLE(50%):81.2 DEG

C0 PLANE ISOLUX DIAGRAM (UNIT:lx)

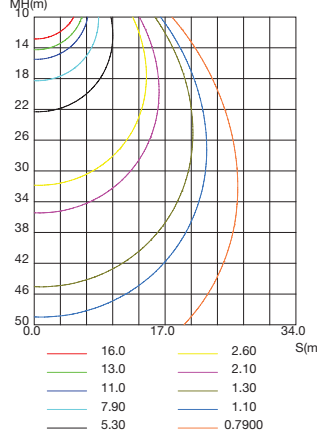

ISOLUX DIAGRAM

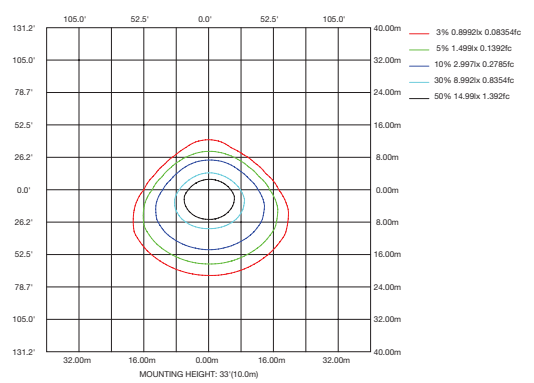

U-AWP-70W-50

LUMINOUS INTENSITY DISTRIBUTION DIAGRAM

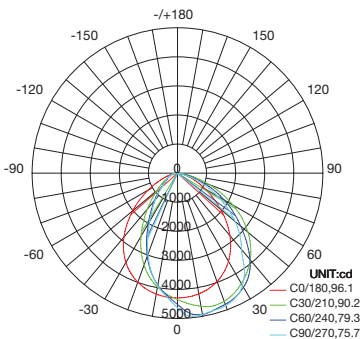

AVERAGE BEAM ANGLE(50%):85.3 DEG

C0 PLANE ISOLUX DIAGRAM (UNIT:lx)

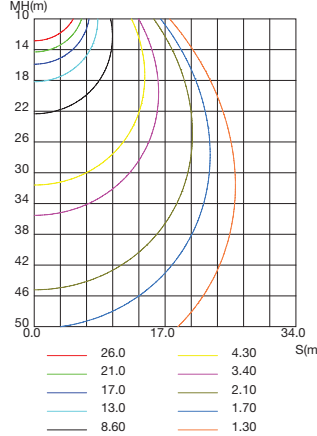

ISOLUX DIAGRAM

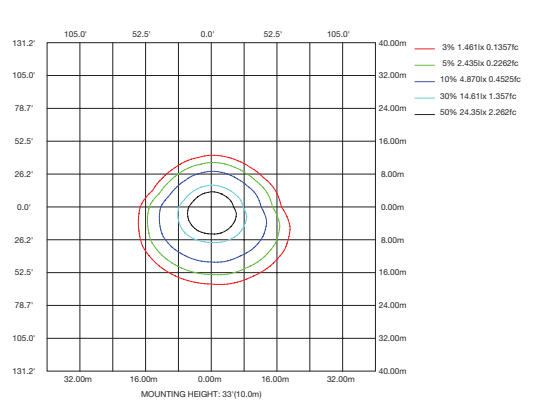

LED Adjustable Wall Pack

PHOTOMETRICS

U-AWP-100W-50

LUMINOUS INTENSITY DISTRIBUTION DIAGRAM

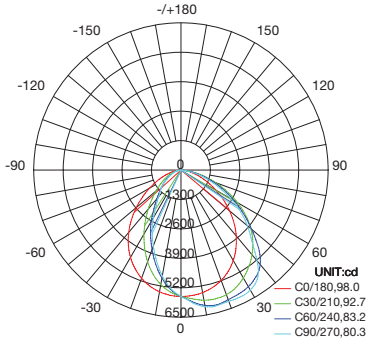

AVERAGE BEAM ANGLE(50%):88.5 DEG

C0 PLANE ISOLUX DIAGRAM (UNIT:lx)

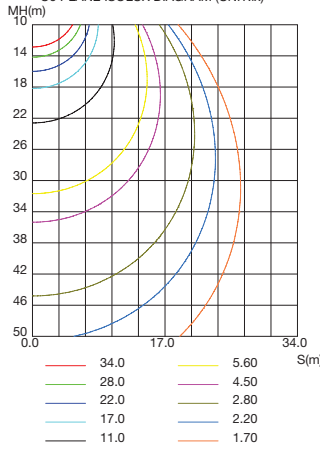

ISOLUX DIAGRAM

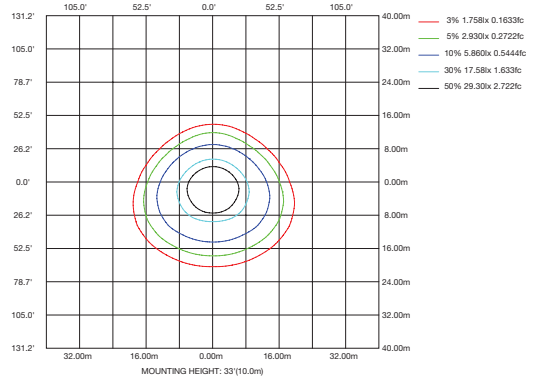

LED Adjustable Wall Pack